



CHENGDU ROSUN DISINFECTION

SE-1 Product Introduction

Makes The
Rivers And Earth Cleaner
Helps Billions
Of People Be Healthier

- 1 History of Disinfection
- 2 SE-1 product introduction
- 3 Authority Certificates
- 4 Application and Facilities

1

History of Disinfection

- **Outbreaks of a series of infectious disease in history because there is no disinfection**
 - Outbreak of plague (Black Death) in the 14th century ,killing half the Europeans, it repeatedly broke out and didn't stop until the 18th century.
 - In 1816, for the first time in human history, cholera pandemic broke out in Bangladesh and India.
 - British cholera pandemic in 1831, affecting almost the half of the Eastern Hemisphere.
 - Chicago cholera pandemic in 1885,claimed 90,000 lives.
 - European Influenza (1917~1919) resulted in 50 million deaths.
- **Disease have been prevented by disinfection**
 - SARS
 - Bird Flu
 - Ebola

Water quality become worse, and water pollution more and more serious

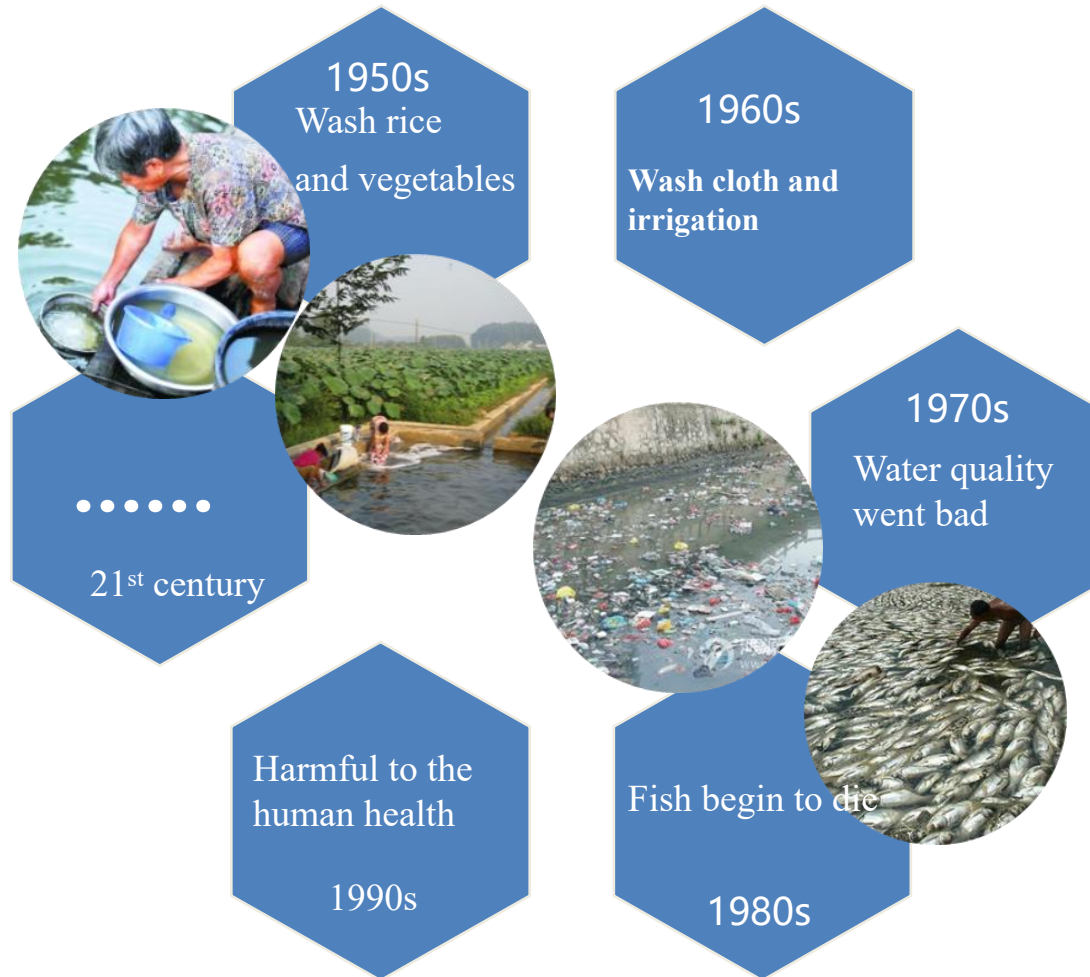

Such kind of water

Have you used?

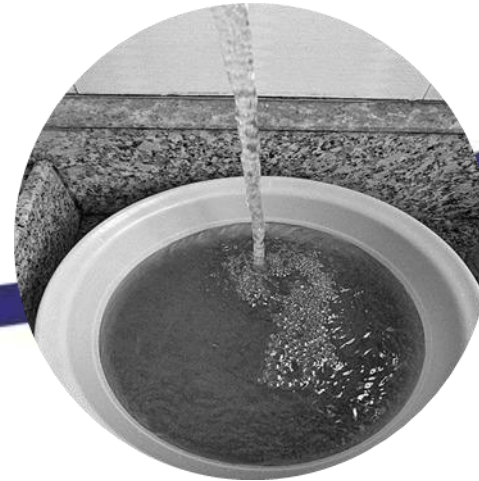

Chemical by-product Problem

When use disinfectant in bad quality water, it will produce a large amount of chemical by-products when meet the organic matter in water.

- Chlorine and its compound, bromine, iodine: THM ,chlorinated disinfection byproduct, doesn't exist in natural water, and is only produced in chlorinated disinfection process. Currently there are over 500 kinds of chlorine disinfection by-products that have been confirmed.
- $\text{HOCl} + \text{Br} + \text{NOM} = \text{THMS} + \text{other haloforms}$
- NOM: Natural organics humic acid and fulvic acid
- THMS: trihalomethanes
- Chlorine dioxide: causing chlorite
- Ozone: bromate is level-2B potential carcinogen, which can be obtained by ozone oxidized into bromine ion, $\text{Br} + \text{O}_3 \rightarrow \text{BrO}_3$

Chemical by-product Problem

- Main chlorine-induced toxic substances confirmed by WHO include:
- 1. Carcinogen:
- THMS, HAAS, halogenated cyanide, haloaldehydes, phenol, etc.
- HAAS: DCAA's carcinogenic risk is 50 times of THMS.
- TCAA: its carcinogenic risk is 100 times of THMS.
- 2. Mutagenicity: typical liver, kidney and bladder mutagenicity of chloroform, bromoform, furaneol, (monobromo-dichloro-methane, dibromo-monochloro-methane)
- 3. Suspected carcinogenic substances: dichloroacetic acid, bromate, formaldehyde

The harmful by-products will be accumulated in aquatic animal, and get into human body after eat them.

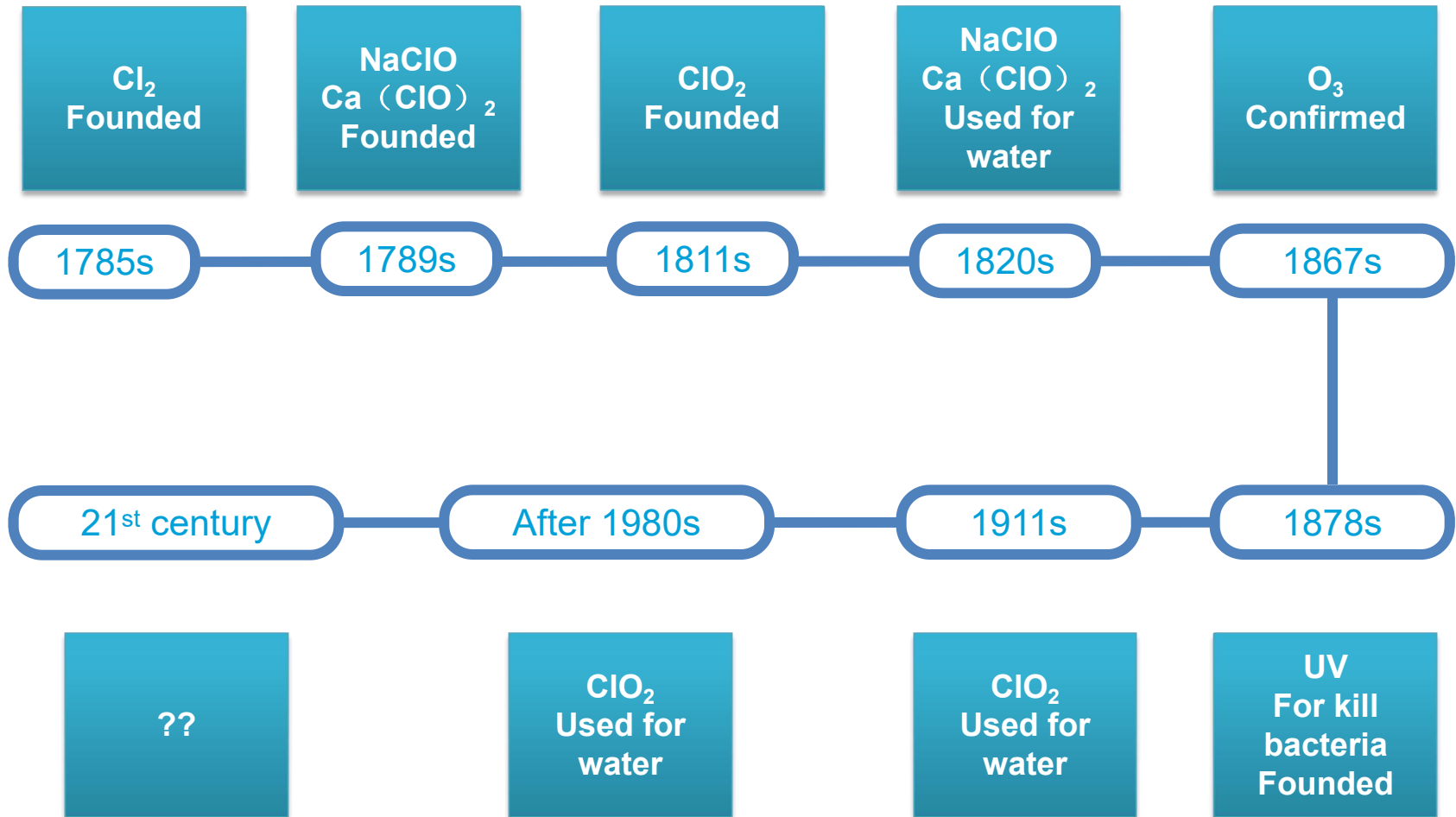

➤ **The existing disinfection in the market**

A: Chlorine(Liquid Chlorine, Calcium Hypochlorite, Sodium hypochlorite, etc.)

- ❖ Low price
- ❖ Danger By-products (carcinogenic, mutagenic and suspected carcinogenic substances)
- ❖ Store and transport difficulty
- ❖ Leakage
- ❖ Flammable and combustible

D: Ultraviolet

- ❖ Good sterilization effect
- ❖ Big influence from floats in water
- ❖ High cost
- ❖ Shall be frequently changed

C: Ozone

- ❖ Good sterilization effect
- ❖ No enduring effect
- ❖ Complex preparation
- ❖ High cost
- ❖ Produce Bromate

B: Chlorine dioxide

- ❖ Good effect and long duration
- ❖ Difficult to store
- ❖ Shall be prepared on site for use
- ❖ Expensive cost
- ❖ Disinfection by-products produced due to complex test technology

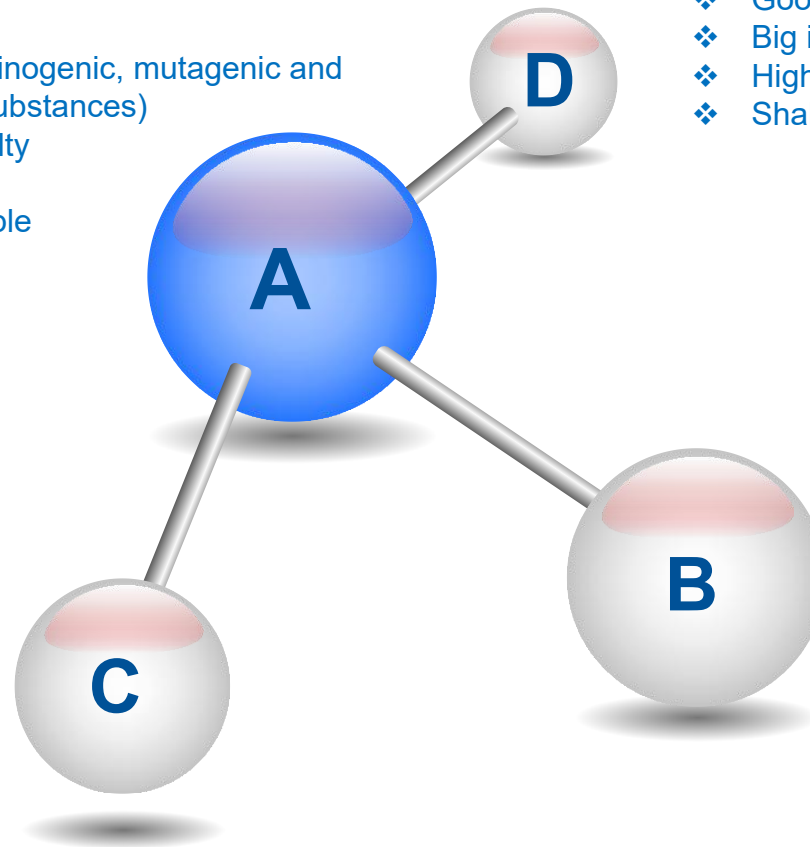

What kind of disinfection method the water company calls for?

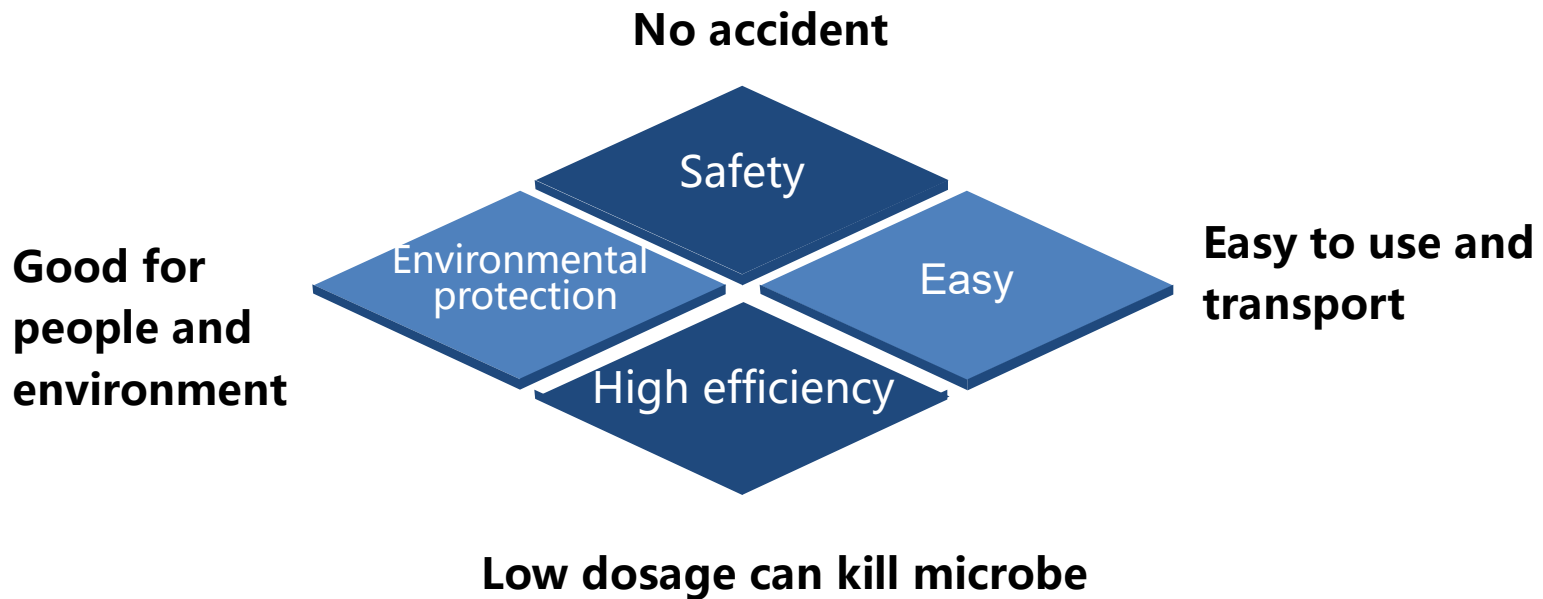

The potassium monopersulfate disinfectant has the advantages shows above.

2

SE-1 product introduction

Potassium monopersulfate triple salt (PMPS)

- In the early 1990s, British use PMPS to treat the foot and mouth disease which spread in European countries, and get excellent result, then European countries started the research of PMPS product, and the series product get used in rapidly.
- Then the different countries have promoted the standard for this chemical:
 In 2000, Germany promoted national standard, standard No, DIN EN 12678:2000
 In 2001, France promoted national standard, standard No. NF T94-309-2001
 In 2002, British promoted national standard, standard No. BS EN 12678

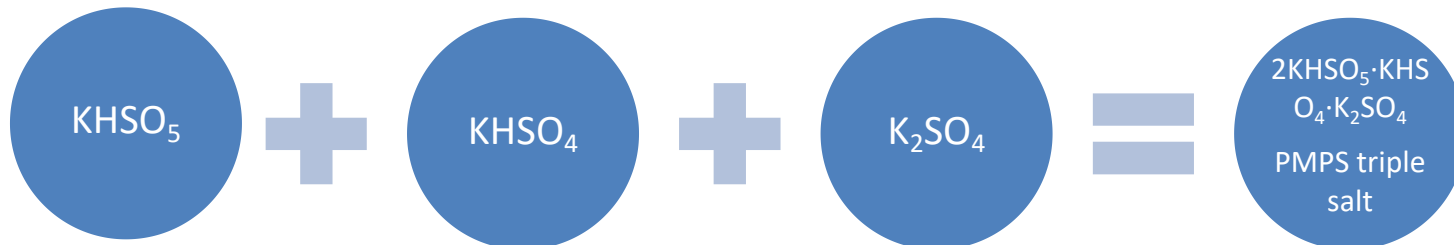

- But as PMPS is not stable, when dissolve in water, it will quickly release oxygen and potassium sulfate, no long lasting efficacy, so usually it used as oxidizer or oxygen supply chemical in aquaculture.

➤ **Rosun disinfectant powder SE-1 core mechanism**

- Rosun use special synergistic activation technology by add activator, synergist, stabilizer inside PMPS, so it is more stable, high efficacy and long lasting.

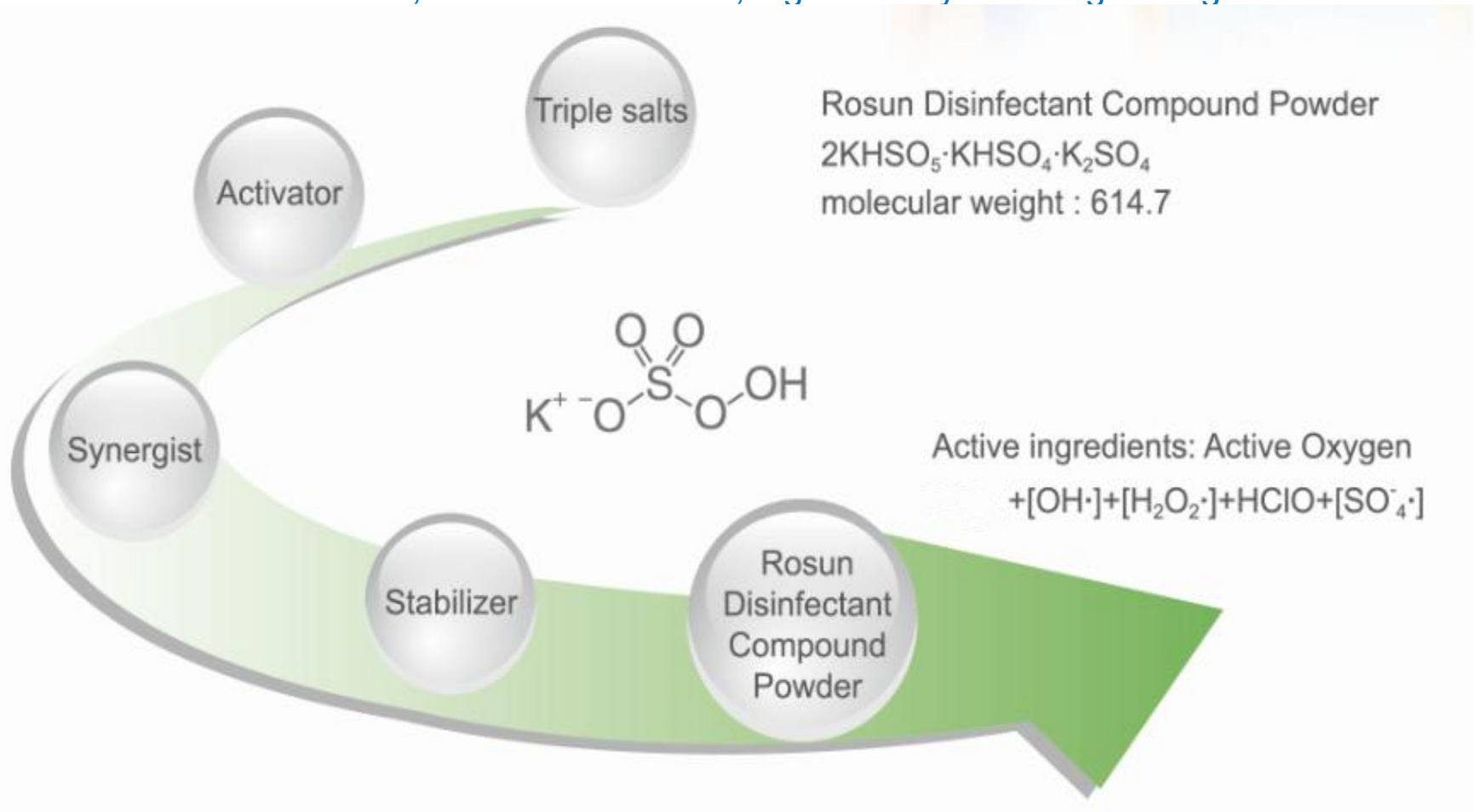

➤ Rosun SE-1--- A new generation disinfection

- Name: Rosun SE-1
- Main components: potassium monopersulfate
- Chemical formula: $2\text{KHSO}_5 \cdot \text{KHSO}_4 \cdot \text{K}_2\text{SO}_4$
- Physical property: white powder
- Solubility: soluble in water



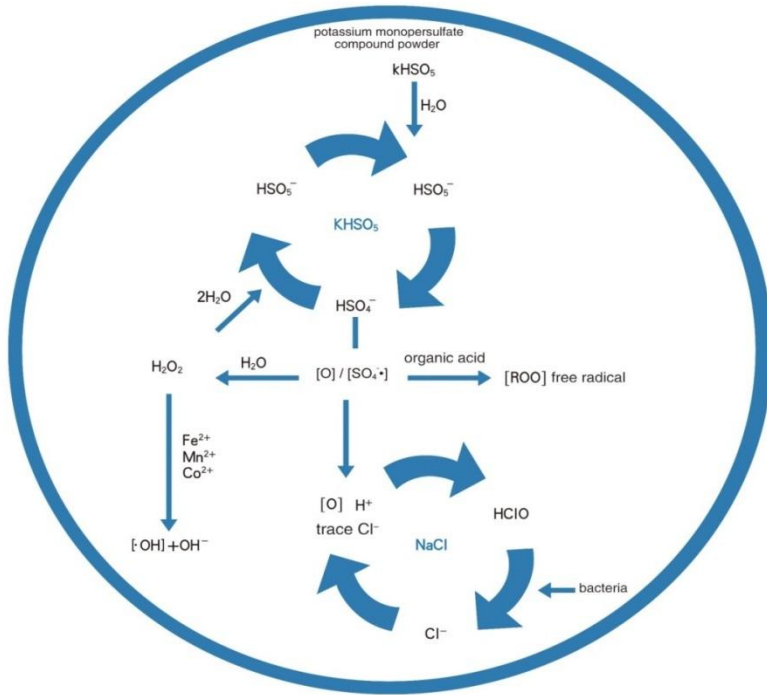

Cycle chain reaction —
long lasting efficacy

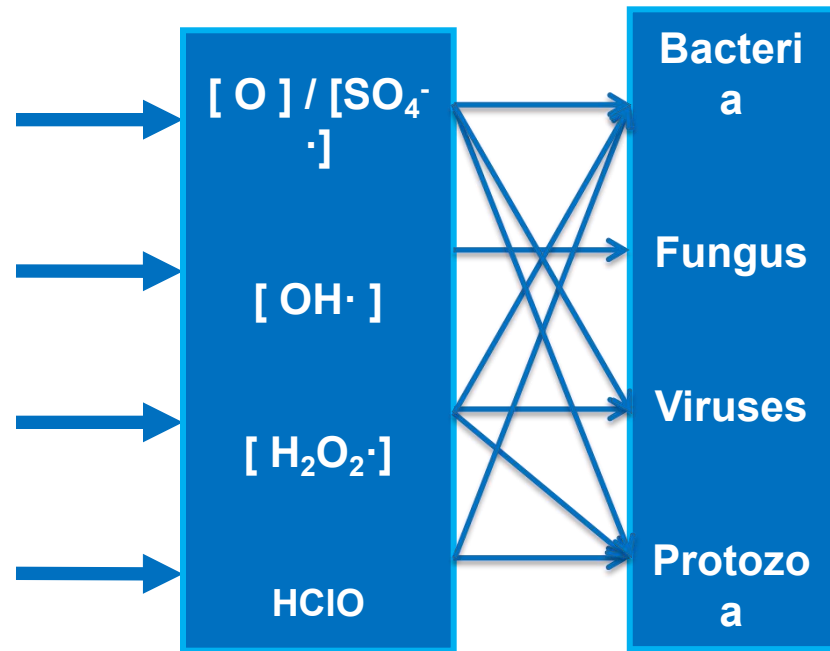

Different kinds of active ingredients — Broad Spectrum

Oxidizing Agent	F ₂	·OH	SO ₄ ·-	O ₃	O	H ₂ O ₂	ClO ₂	HClO	Cl ₂
Oxidation Potential	3.06	2.80	2.5-3.1	2.07	1.84	1.77 (pH<7)	1.5	1.48	1.36

High oxidation Potential — High efficacy

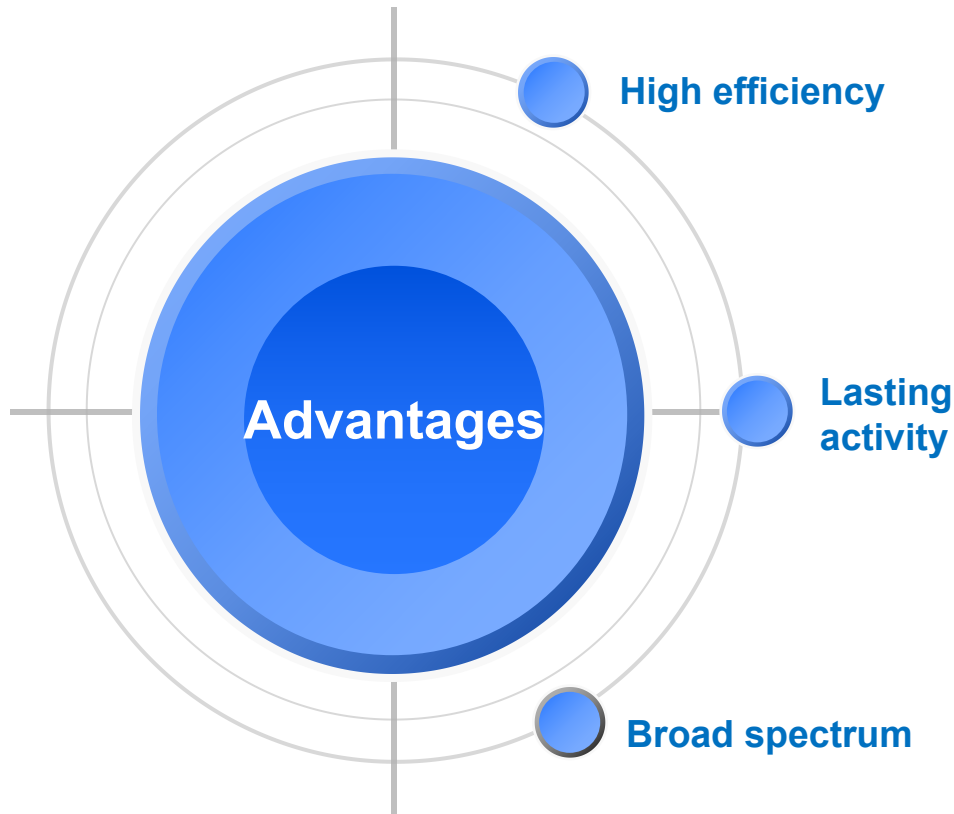

- Continuously produce active ingredients, sterilization over 99.9% bacterial.

- Release active ingredients continuously, efficacy last for lone time.

- Many active ingredients make this product have super broad-spectrum sterilization effect, the antibacterial spectrum includes bacteria, viruses, fungi, bacteria spores, protozoa, algae spores, etc.

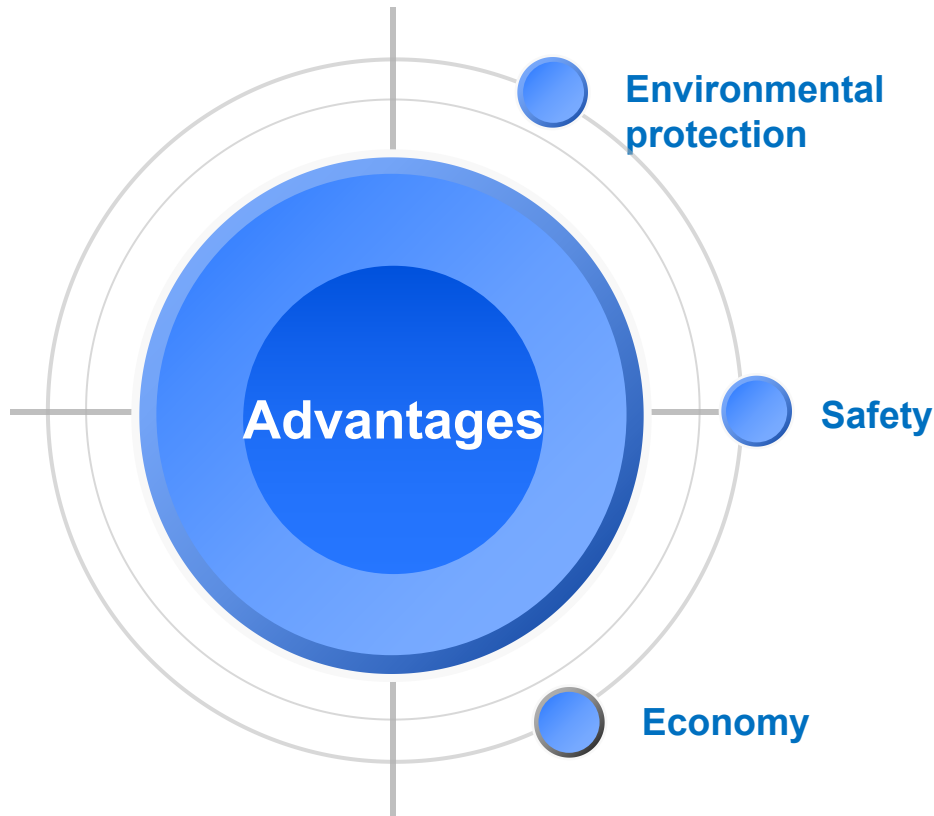

- Rosun disinfectant powder can reduce and prevent the production of harmful substances that may lead to carcinogenesis, teratogenesis and mutagenesis, such as organic chloride.

- This product is a powder disinfectant, so there is no danger during the production, transportation, storage and application which liquid chlorine caused.

- Lower disinfectant consumption, higher equipment cost-effective, longer service life and low maintenance cost.

3

Authority Certificates

Standard/Guidance

Extract content:

Potassium monopersulfate (SE-1) Sterilization characteristics

- The concentration of the Active oxygen is 7%-9%. only need 15min to kill most microorganism in water.
- Cycled chain reaction in water, continuous release Active oxygen and other Free Radical, so the Sterilization effect can last for long time in water.
- Different active ingredients coexist together, which lead to broad spectrum
- The killing effect is hardly influenced.
- Not produce harmful residue, only little K^+ , SO_4 contribution.



➤ **Test results (Bacteria killing test experiment)**

1



Quantitative Escherichia Coli Killing Test

The disinfectant solution which potassium monopersulfate content is 250mg/L, affected for 20min, the average killing logarithm value of escherichia coli is larger than 5.00. Based on evaluation standard, the disinfectant accordance with disinfectant sterilization requirements.

2

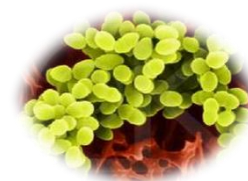

Quantitative Staphylococcus Aureus Killing Test

The disinfectant solution which potassium monopersulfate content is 250mg/L, affected for 20min, the average killing logarithm value of staphylococcus aureus is larger than 5.00. Based on evaluation standard, the disinfectant accordance with disinfectant sterilization requirements.

3

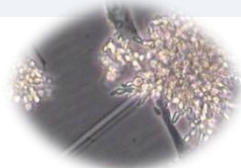

Quantitative Candida Albicans Killing Test

The disinfectant solution which potassium monopersulfate content is 250mg/L, affected for 20min, the average killing logarithm value of Candida albicans is larger than 4.00. Based on evaluation standard, the disinfectant accordance with disinfectant sterilization requirements.

4



Quantitative Spores of Bacillus Subtilis Var Niger Killing Test

The disinfectant solution which potassium monopersulfate content is 3000mg/L, affected for 60min, the average killing logarithm value of Spores of bacillus subtilis var niger is larger than 5.00. Based on evaluation standard, the disinfectant accordance with disinfectant sterilization requirements.

➤ **Test results (Toxicological experiment)**

1 Toxicity

The acute toxicity LD₅₀ of this disinfectant to mice is 5000mg/kg, and based on the grades of acute toxicity of chemicals, it is low toxicity; by 90000mg/kg solution, the acute toxicity LD₅₀ to mice is more than 5000 mg/kg, and based on the grades of acute toxicity of chemicals, it has no toxicity.

3 Micronuclei of polychromatic erythrocytes of mouse bone marrow

210mg/kg, 840mg/kg, 2100mg/kg tests were done to test the disinfectant on the micronuclei of polychromatic erythrocytes of mouse bone marrow, and the result shows negative.

2 Mouse sperm shape abnormality

210mg/kg, 840mg/kg, 2100mg/kg tests were done to test the disinfectant mouse sperm shape abnormality, and the result shows negative.

4 Subacute toxicity

According to 420mg/kg, 840mg/kg, 1400mg/kg rat test, no obvious toxic symptom detected. During the whole test period, there is no rat death. There is no abnormal change of rat weight, body rate in the three dose groups, and histopathology test results indicate no tested high dose group causes toxic damage

4

Application and Facilities

➤ **Rosun disinfectant powder SE-1**

- Application area :City Sewage Water Disinfection

- Achievement :

1.Number of total sewage plants: app.4000

2.Number of sewage plant that use Rosun SE-1: app.100

3.The biggest handling capacity of sewage plant :640,000 m³



SE-1

Disinfection Object	Guide dosage	Contact Time	Instructions for use
City Sewage water	1.5-5g/m ³	20-30min	Dissolve to 1%~2% solution by plastic drum, then add the solution in the water that need to treat by dosing pump continuously.
Swimming Pool	2~5g/m ³	15-20min	Dissolve to 1%~2% solution by plastic drum, then add the solution in swimming pool by manual or dosing pump.
Industrial Circulating water	8-30g/m ³	15-20min	Directly add into the water inlet of the pool or circulating water pump.

➤ **Dosing equipment**



Optimized type



High-end type

Equipment Principle

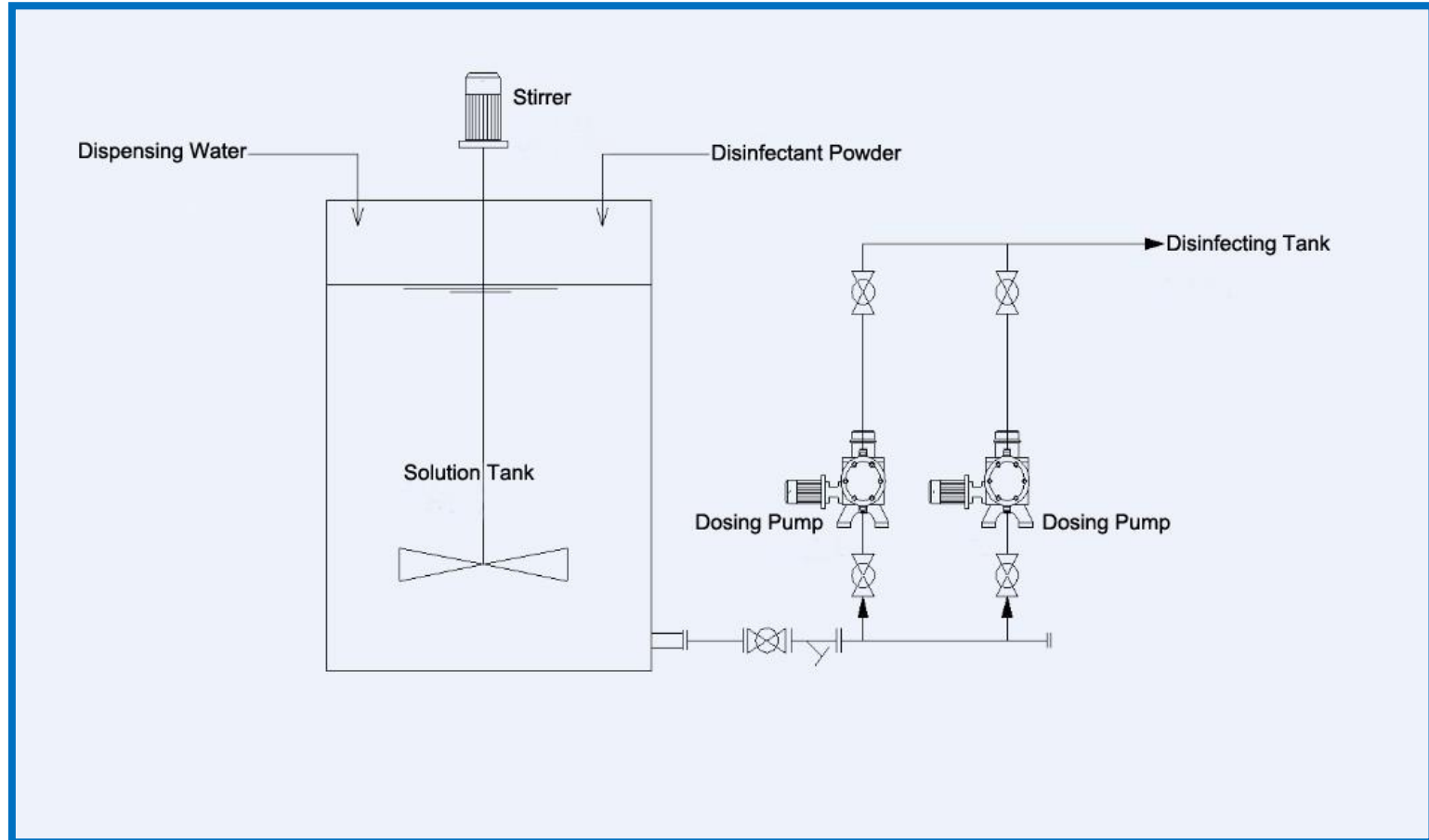

The equipment principle is quite simple, can refit the recent dosing equipment or build a simple dosing system.

➤ Active Ingredient Tester

1. Take a certain amount of sample water by colorimetric cylinder, add 1 pack of test kit, shake up to make it dissolve completely.
2. Wipe off the water and fingerprint on the colorimetric cylinder, after the bubble gone, compare the color with the card.



The active ingredient tester can show the bacteria situation in water indirectly, it is very easy to bring and use.

➤ **Application Example(SE-1)**

Plant Name	Plant Situation
Nanjing Jiang Xin Zhou sewage water plant	640,000(m ³ /day)
Yan'an Comprehensive sewage plant	30000(m ³ /day)
Chengdu Water Affairs Group	Include 30 water plants, total capacity 3000,000m ³ /day
Leshan waste water plant	2000m ³ /day
Chongqing Water Affairs Group	Include 36 water plants, total capacity 1683,000m ³ /day

Thank you

Chengdu Rosun Disinfection Pharmaceutical Co., Ltd

Makes The Rivers And Earth Cleaner , Helps Billions Of People Be Healthier

